



University
of Manitoba

WINTER OPEN HOUSE

THURSDAY, FEBRUARY 20
9 AM – 3 PM
UMSU UNIVERSITY CENTRE
FORT GARRY CAMPUS



INFORMATION VILLAGE

MPR Room 210-224, 2nd Floor, UMSU University Centre

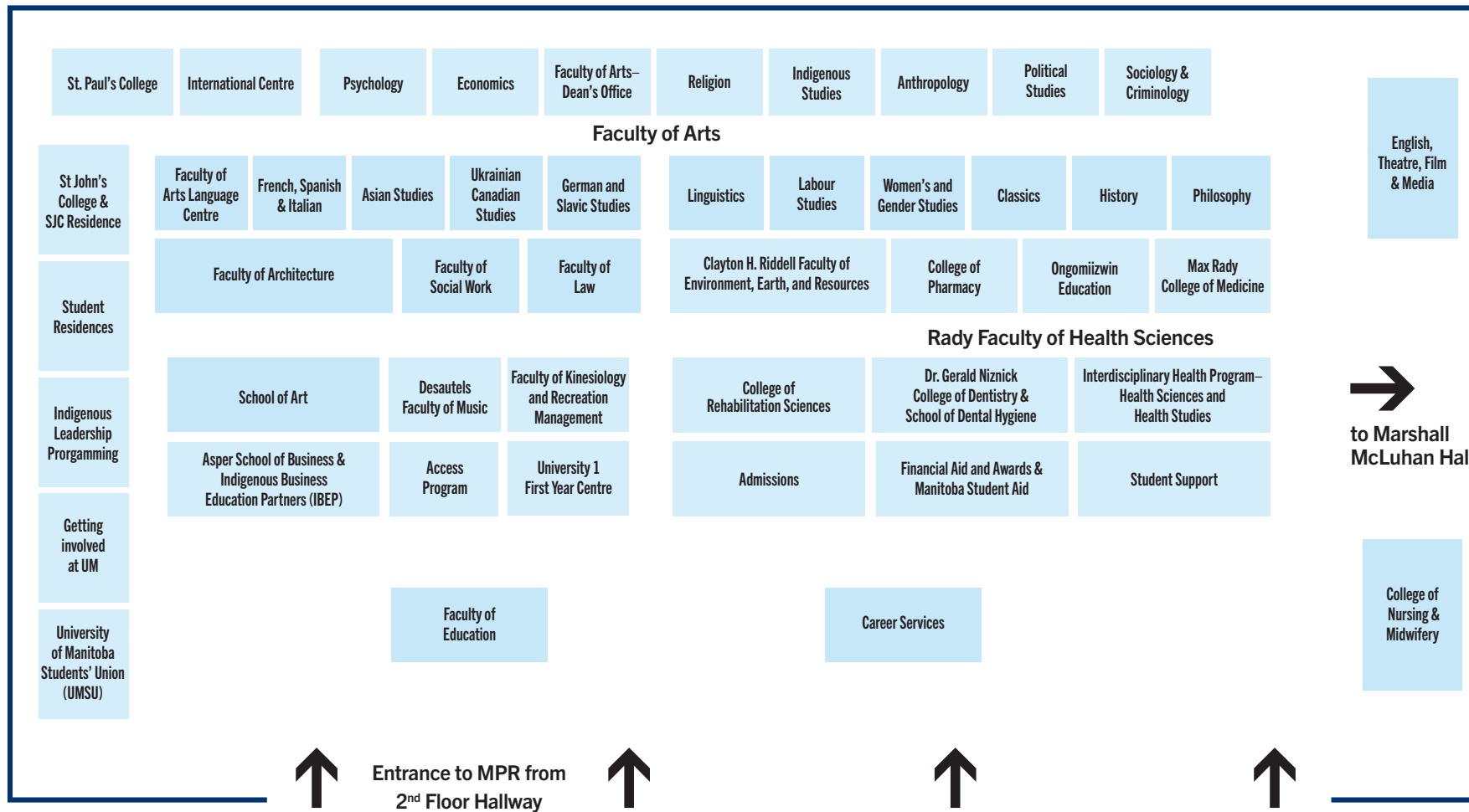

Second Floor Hallway

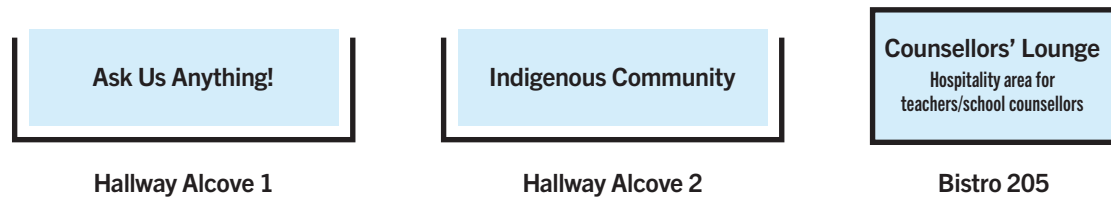

INFORMATION VILLAGE

Marshall McLuhan Hall, Room 204

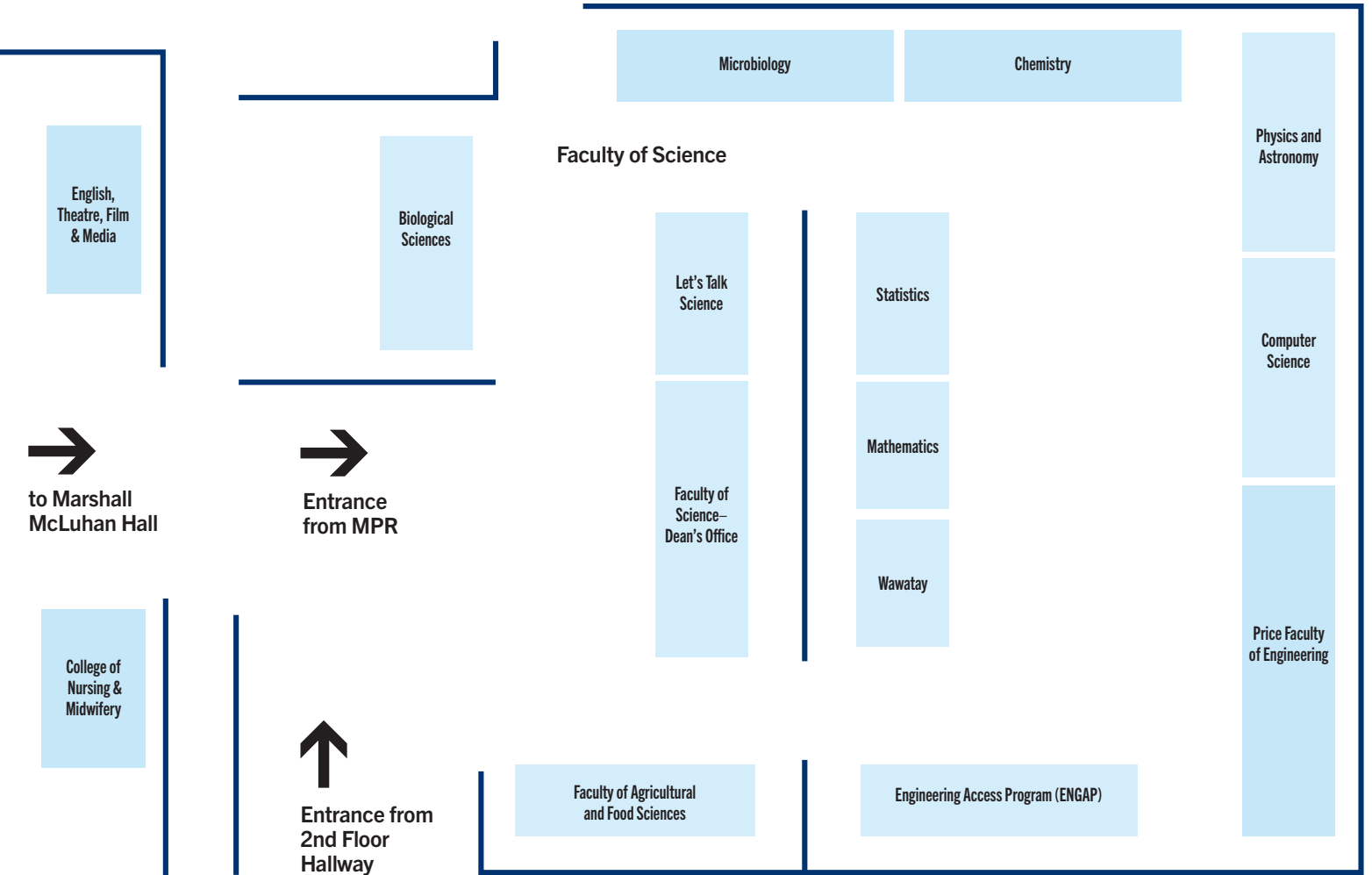

PRESENTATIONS AND TOURS

Fireside Lounge and CAMPO
1st floor, UMSU University Centre

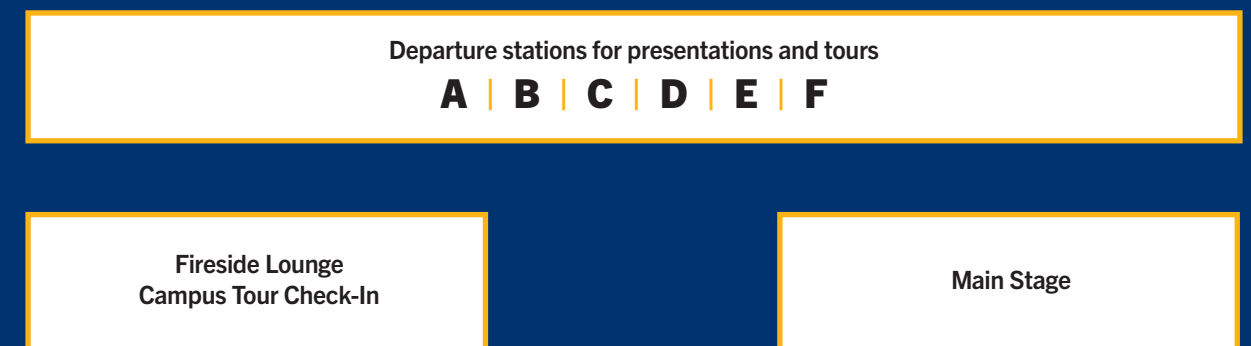

GRADE 12 STUDENTS

Check-in for a chance to win a **\$3,000 tuition prize** to be applied to your 2025-26 UM tuition fees. All other students will be entered to win a UM prize pack!

PRESENTATIONS ON-DEMAND

Missed a presentation? Watch videos spotlighting our programs, services for students, and how to apply in our Open House video library.



TOUR CAMPUS FROM ANY DEVICE

Explore the Fort Garry campus and step into classrooms, labs and faculty buildings using our 360 Virtual Tour, available to view on any device!



EXPLORE UM

To learn more about programs, the student experience or to explore our campuses, visit umanitoba.ca/explore



CONTACT US

P: 204-474-8808

E: student_recruitment@umanitoba.ca

indigenous_recruitment@umanitoba.ca

CONNECT WITH US

 /umanitoba
/IndigenousStudentCentreUofM

 /umanitoba

 @umanitoba

 @umanitoba
@umindigenous

 @umstudent

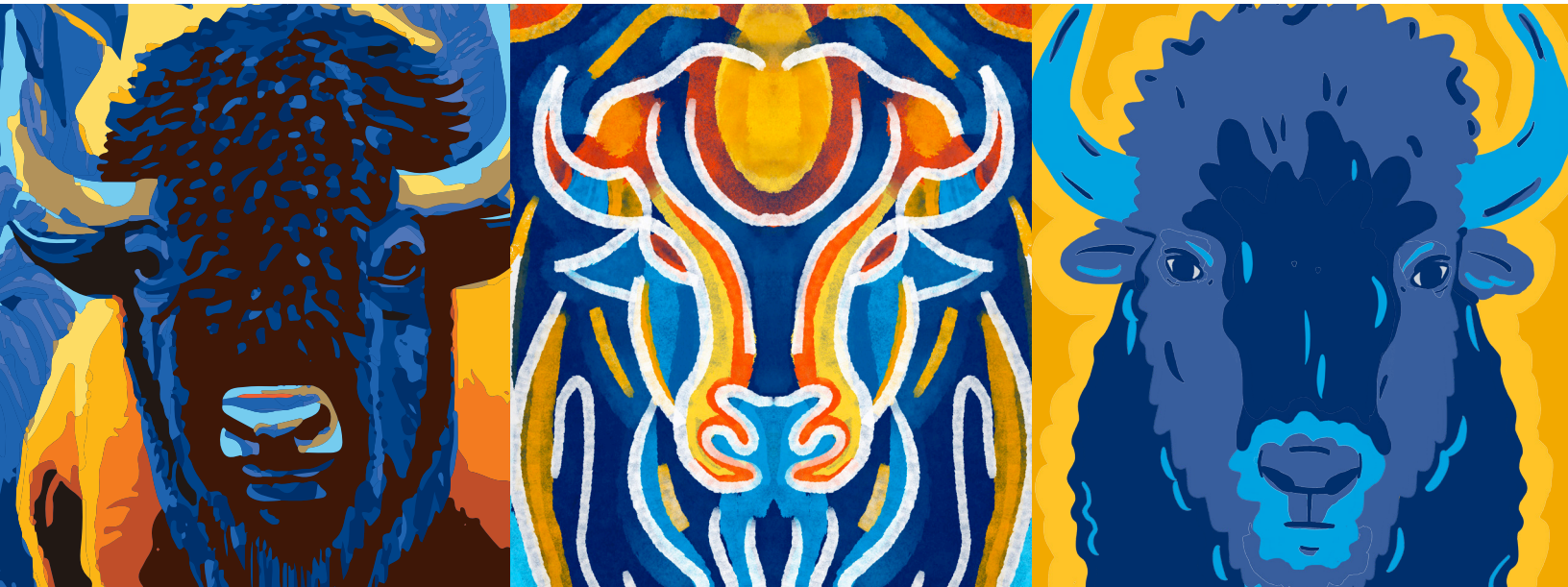

WINTER OPEN HOUSE

PRESENTATION AND TOUR SCHEDULE



University
of Manitoba

Choose a presentation or tour from the options below and arrive at the designated departure station 5 minutes before the start time. Campus tours leave from the Fireside Lounge, while all other departure stations are located on the 1st floor of the UMSU University Centre. Each presentation or tour will generally last about 45 minutes, so you won't be able to attend all of them.

| TIME | DEPARTURE STATION <i>1st Floor, UMSU University Centre</i> |
|------|---|
|------|---|

9–10 AM

| | |
|---|-----------------|
| Asper School of Business Info Session | C |
| The University FAQ: Everything You Need to Know | D |
| Faculty of Science Info Session | E |
| Campus Tour | Fireside Lounge |

9:30–10:30 AM

| | |
|---|-----------------|
| Residence Tour | A |
| Migizii Agamik - Indigenous Student Centre Tour | B |
| Midwifery Info Session | C |
| University 1 Info Session | D |
| Dentistry Info Session | E |
| Campus Tour | Fireside Lounge |

10–11 AM

| | |
|--|-----------------|
| Active Living Centre Tour | A |
| Getting Involved at University | B |
| Agriculture - Plant Biotechnology Info Session | C |
| Engineering Info Session & Tour | D |
| Physics and Astronomy Sample Lecture | E |
| Education Info Session | F |
| Campus Tour | Fireside Lounge |

10:30–11:30 AM

| | |
|--|-----------------|
| Residence Tour | A |
| Migizii Agamik - Indigenous Student Centre Tour | B |
| Kinesiology and Recreation Management Info Session | C |
| Career Planning | D |
| Dentistry Info Session | E |
| Pharmacy Info Session | F |
| Campus Tour | Fireside Lounge |

11 AM–12 PM

| | |
|---|-----------------|
| Agriculture - Agronomy Info Session | A |
| Dental Hygiene Info Session | B |
| Asper School of Business Info Session | C |
| Health Sciences & Health Studies Info Session | D |
| Environment, Earth and Resources Lab Tours | E |
| Social Work Sample Lecture | F |
| Campus Tour | Fireside Lounge |

11:30–12:30 PM

| | |
|---------------------------------|-----------------|
| Residence Tour | A |
| Active Living Centre Tour | B |
| Nursing Info Session | C |
| University 1 Info Session | D |
| Computer Science Sample Lecture | E |
| School of Art Info Session | F |
| Campus Tour | Fireside Lounge |

12–1 PM

| | |
|---|-----------------|
| Agricultural and Food Sciences Degree Programs Info Session | A |
| Migizii Agamik - Indigenous Student Centre Tour | B |
| Career Planning | C |
| Engineering Info Session & Tour | D |
| Faculty of Arts Info Session | E |
| The University FAQ: Everything You Need to Know | F |
| Campus Tour | Fireside Lounge |

12:30–1:30 PM

| | |
|---|-----------------|
| Indigenous Community Info Session | A |
| Law Info Session | C |
| Health Sciences & Health Studies Info Session | D |
| Faculty of Science Info Session | E |
| Student Panel: Q&A with Current Students | F |
| Campus Tour | Fireside Lounge |

1–2 PM

| | |
|--|-----------------|
| Residence Tour | A |
| Getting Involved at University | B |
| Agriculture - Diploma Program Info Session | C |
| Dental Hygiene Info Session | D |
| Education Info Session | E |
| Campus Tour | Fireside Lounge |

1:30–2:30 PM

| | |
|---|-----------------|
| Migizii Agamik - Indigenous Student Centre Tour | A |
| Mathematics Sample Lecture | C |
| Pharmacy Info Session | D |
| Environment, Earth and Resources Lab Tours | E |
| Campus Tour | Fireside Lounge |

2–3 PM

| | |
|----------------------------------|-----------------|
| Residence Tour | A |
| Active Living Centre Tour | C |
| Biological Sciences Info Session | D |
| Campus Tour | Fireside Lounge |

On-Going

| | |
|---|--------------------------|
| Faculty of Architecture Building Workshop | Centre Space, |
| Walk-up activities | John A. Russell Building |



FORT GARRY CAMPUS

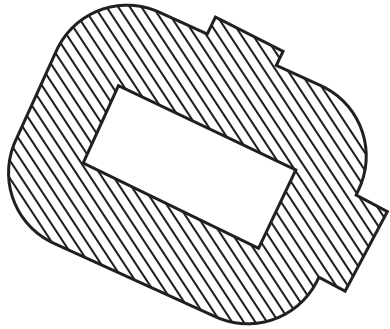

EXPLORE OUR CAMPUS

Self-guided walking tour:



360° virtual tour:

